

CS 458 / 658
Computer Security and Privacy

Module 3
Operating System Security

Fall 2023

Operating systems

- An operating system allows different “entities” to access different resources in a **shared way**
- The operating system needs to control this sharing and provide an interface to allow this access
- **Identification** and **authentication** are required for this access control
- We will start with memory protection techniques and then look at access control in more general terms

Module outline

- 1 Protection in general-purpose operating systems
- 2 Access control
- 3 User authentication
- 4 Security policies and models
- 5 Trusted operating system design

Module outline

- 1 Protection in general-purpose operating systems
- 2 Access control
- 3 User authentication
- 4 Security policies and models
- 5 Trusted operating system design

History

- Operating systems evolved as a way to allow multiple users use the same hardware
 - Sequentially (based on **executives**)
 - Interleaving (based on **monitors**)

Sequential Vs Interleaving Execution

Sequential Execution

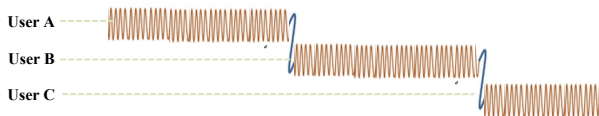

Interleaving Execution

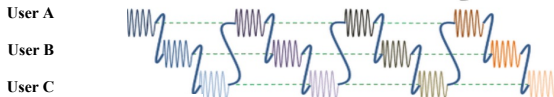

History

- Operating systems evolved as a way to allow multiple users use the same hardware
 - Sequentially (based on **executives**)
 - Interleaving (based on **monitors**)
- OS makes resources available to users if required by them and permitted by some policy
- OS also protects users from each other
why?
- Even for a single-user OS, protecting a user from him/herself is a good thing
why?

History

- Operating systems evolved as a way to allow multiple users use the same hardware
 - Sequentially (based on **executives**)
 - Interleaving (based on **monitors**)
- OS makes resources available to users if required by them and permitted by some policy
- OS also protects users from each other
 - Attacks, mistakes, resource overconsumption
- Even for a single-user OS, protecting a user from him/herself is a good thing
 - Mistakes, malware

Protected objects

- Memory
- Data
- CPU
- Programs
- I/O devices (disks, printers, keyboards, sensors, ...)
- Networks
- OS

Separation

- Keep one user's objects separate from other users
- **Physical** separation
 - Use different physical resources for different users
 - Problems?
- **Temporal** separation
 - Execute different users' programs at different times
- **Logical** separation
 - User is given the impression that no other users exist
 - As done by an operating system
- **Cryptographic** separation
 - Encrypt data and make it unintelligible to outsiders
 - Complex

Separation

- Keep one user's objects separate from other users
- **Physical** separation
 - Use different physical resources for different users
 - Easy to implement, but expensive and inefficient
- **Temporal** separation
 - Execute different users' programs at different times
- **Logical** separation
 - User is given the impression that no other users exist
 - As done by an operating system
- **Cryptographic** separation
 - Encrypt data and make it unintelligible to outsiders
 - Complex

Sharing

- Sometimes, users do want to share resources
 - Library routines (e.g., libc)
 - Files or database records
- OS should allow **flexible sharing**, not “all or nothing”
 - Which files or records? Which part of a file/record?
 - Which other users?
 - Can other users share objects further?
 - What uses are permitted?
 - Read but not write, view but not print (Feasibility?)
 - Aggregate information only
 - For how long?

Memory and address protection

- Prevent one program from corrupting other programs or data, operating system and maybe itself
- Often, the OS can exploit **hardware support** for this protection, so it's cheap
 - See CS 350 memory management slides
- Memory protection is part of translation from virtual to physical addresses
 - Memory management unit (MMU) generates exception if something is wrong with virtual address or associated request
 - OS maintains mapping tables used by MMU and deals with raised exceptions

Protection techniques

- **Fence register**
 - Exception if memory access below address in fence register
 - Protects operating system from user programs
 - Single-user OS only

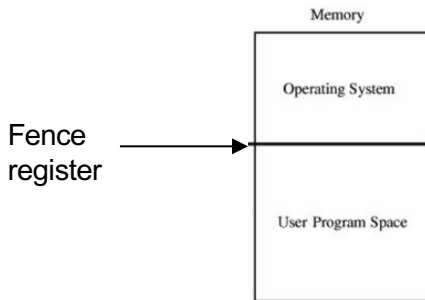

Protection techniques

- **Base/bounds register pair**
 - Exception if memory access below/above address in base/bounds register
 - Different values for each user program
 - Maintained by operating system during context switch
 - Limited flexibility

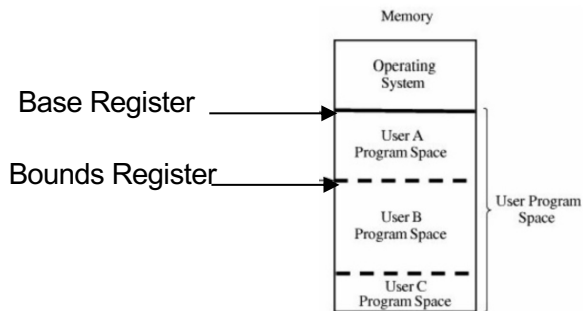

Protection techniques

- **Tagged architecture**
 - Each memory word has one or more extra bits that identify access rights to word
 - Very flexible
 - Large overhead
 - Difficult to port OS from/to other hardware architectures
- **Segmentation**
- **Paging**

Segmentation

- Each program has multiple address spaces (**segments**)
- Different segments for code, data, and stack
 - Or maybe even more fine-grained, e.g., different segments for data with different access restrictions
- Virtual addresses consist of two parts:
 - **<segment name, offset within segment>**
- OS keeps mapping from segment name to its base physical address in **Segment Table**
 - A segment table for each process
- OS can (transparently) relocate or resize segments and share them between processes
- Segment table also keeps protection attributes

Segment table

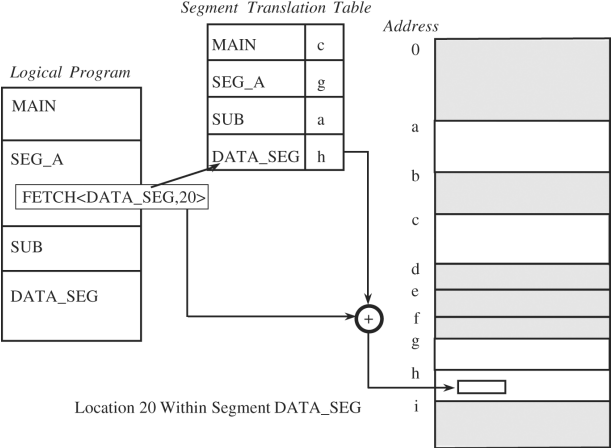

Protection attributes and segment length are missing in table

Review of segmentation

- Advantages:
 - Each address reference is checked for protection by hardware
 - Many different classes of data items can be assigned different levels of protection
 - Users can share access to a segment, with potentially different access rights
 - Users cannot access an unpermitted segment
- Disadvantages:
 - External fragmentation
 - Dynamic length of segments requires costly out-of-bounds check for generated physical addresses
 - Segment names are difficult to implement efficiently

Paging

- Program (i.e., virtual address space) is divided into equal-sized chunks (**pages**)
- Physical memory is divided into equal-sized chunks (**frames**)
- Frame size equals page size
- Virtual addresses consist of two parts:
 - **<page #, offset within page>**
 - # bits for offset = $\log_2(\text{page size})$
- OS keeps mapping from page # to its base physical address in **Page Table**
- Page table also keeps memory protection attributes

Paging

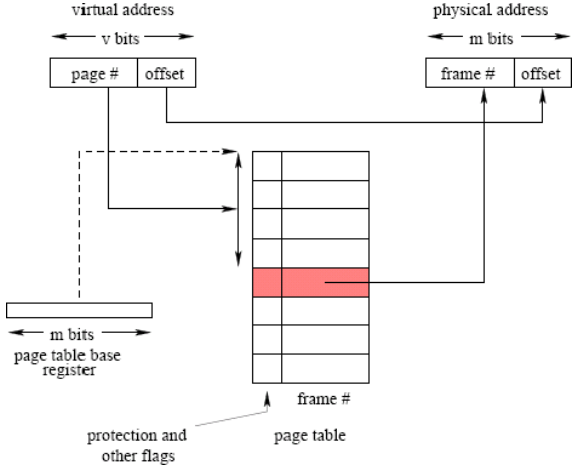

Source: CS 350 slides

Review of paging

- Advantages:
 - Each address reference is checked for protection by hardware
 - Users can share access to a page, with potentially different access rights
 - Users cannot access an unpermitted page
 - Unpopular pages can be moved to disk to free memory
- Disadvantages:
 - Internal fragmentation
 - Assigning different levels of protection to different classes of data items not feasible

x86 architecture

- x86 architecture has both segmentation and paging
 - Linux and Windows use both
 - Only simple form of segmentation, helps portability
 - Segmentation cannot be turned off on x86
- Memory protection bits indicate no access, read/write access or read-only access
- Most processors also include **NX (No eXecute) bit**, forbidding execution of instructions stored in page
 - E.g., make stack/heap non-executable
 - Does this avoid all buffer overflow attacks?

Module outline

- 1 Protection in general-purpose operating systems
- 2 Access control
- 3 User authentication
- 4 Security policies and models
- 5 Trusted operating system design

Access control

- Memory is only one of many objects for which OS has to run access control
- In general, access control has three goals:
 - **Check every access**: Else OS might fail to notice that access has been revoked
 - **Enforce least privilege**: Grant program access only to **smallest** number of objects required to perform a task
 - **Verify acceptable use**: Limit types of activity that can be performed on an object
 - E.g., for integrity reasons (ADTs)

Access control structures

- Access control matrix
- Access control lists
- Privilege lists, Capabilities
- Role-based access control

Access control matrix

- Set of protected objects: O
 - E.g., files or database records
- Set of subjects: S
 - E.g., humans (users), processes acting on behalf of humans or group of humans/processes
- Set of rights: R
 - E.g., read, write, execute, own
- Access control matrix consists of entries $a[s,o]$, where $s \in S$, $o \in O$ and $a[s,o] \subseteq R$

Example access control matrix

	File 1	File 2	File 3
Alice	orw	rx	o
Bob	r	orx	
Carol		rx	

Implementing access control matrix

- Access control matrix is rarely implemented as a matrix
 - Why?
- Instead, an access control matrix is typically implemented as
 - a set of **access control lists**
 - column-wise representation
 - a set of **capabilities**
 - row-wise representation
 - or a combination

Access control lists (ACLs)

- Each object has a list of subjects and their access rights
 - File 1: Alice:orw, Bob:r, File 2: Alice:rx, Bob:orx, Carol:rx
 - ACLs are implemented in Windows file system (NTFS), user entry can denote entire user group (e.g., “Students”)
 - Classic UNIX file system has simple ACLs. Each file lists its owner, a group and a third entry representing all other users. For each class, there is a separate set of rights. Groups are system-wide defined in /etc/group, use chmod/chown/chgrp for setting access rights to your files

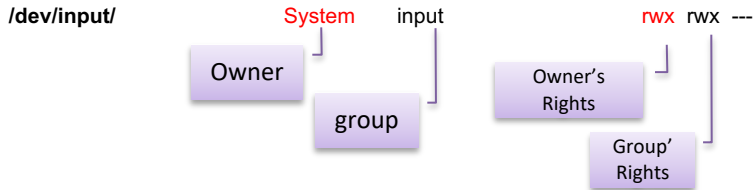

Access control lists (ACLs)

- Each object has a list of subjects and their access rights
 - File 1: Alice:orw, Bob:r, File 2: Alice:rx, Bob:orx, Carol:rx
 - ACLs are implemented in Windows file system (NTFS), user entry can denote entire user group (e.g., “Students”)
 - Classic UNIX file system has simple ACLs. Each file lists its owner, a group and a third entry representing all other users. For each class, there is a separate set of rights. Groups are system-wide defined in /etc/group, use chmod/chown/chgrp for setting access rights to your files
- Which of the following can we do quickly for ACLs?
 - Determine set of allowed users per object
 - Determine set of objects that a user can access
 - Revoke a user’s access right to an object or all objects

Capabilities

- A capability is an **unforgeable token** that gives its owner some access rights to an object
 - Alice: File 1:orw, File 2:rx, File 3:o
- Unforgeability enforced by having OS store and maintain tokens or by cryptographic mechanisms
 - E.g., digital signatures (see later) allow tokens to be handed out to processes/users. OS will detect tampering when process/user tries to get access with modified token.
- Tokens might be transferable (e.g., if anonymous)
- Some research/experimental OSs (e.g., Hydra, Fuchsia) have fine-grained support for tokens
 - Caller gives callee procedure only minimal set of tokens
- Answer questions from previous slide for capabilities

Combined usage of ACLs and cap.

- In some scenarios, it makes sense to use both ACLs and capabilities
 - Why?
- In a UNIX file system, each file has an ACL, which is consulted when executing an `open()` call
- If approved, caller is given a capability listing type of access allowed in ACL (read or write)
 - Capability is stored in memory space of OS
- Upon `read()/write()` call, OS looks at capability to determine whether type of access is allowed
- Problem with this approach?

Role-based access control (RBAC)

- In a company, objects that a user can access often do not depend on the identity of the user, but on the user's job function (role) within the company
 - Salesperson can access customers' credit card numbers, marketing person only customer names
- In RBAC, administrator assigns users to roles and grants access rights to roles
 - Sounds similar to groups, but groups are less flexible
- When a user takes over new role, need to update only her role assignment, not all her access rights
- Available in many commercial databases

RBAC extensions

- RBAC also supports more complex access control scenarios
- **Hierarchical roles**
 - “A manager is also an employee”
 - Reduces number of role/access rights assignments
- Users can have **multiple roles** and assume/give up roles as required by their current task
 - “Alice is a manager for project A and a tester for project B”
 - User’s current session contains currently initiated role
- **Separation of Duty**
 - “A payment order needs to be signed by both a manager and an accounting person, where the two cannot be the same person”

Module outline

- 1 Protection in general-purpose operating systems
- 2 Access control
- 3 User authentication
- 4 Security policies and models
- 5 Trusted operating system design

User authentication

- Computer systems often have to **identify** and **authenticate** users before **authorizing** them
- Identification: Who are you?
- Authentication: Prove it!
- Identification and authentication is easy among people that know each other
 - For your friends, you do it based on their face or voice
- More difficult for computers to authenticate people sitting in front of them
- Even more difficult for computers to authenticate people accessing them remotely

User authentication

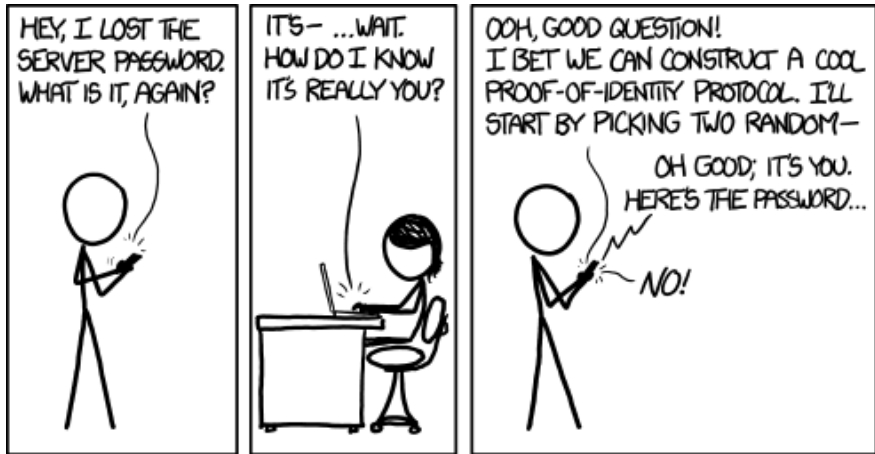

<https://xkcd.com/1121/>

Authentication factors

- Three classes of authentication factors
- Something the user **knows**
 - Password, PIN, answer to “secret question”
- Something the user **has**
 - ATM card, badge, browser cookie, physical key, uniform, smartphone
- Something the user **is**
 - Biometrics (fingerprint, voice pattern, face, . . .)
 - Have been used by humans forever, but only recently by computers

Authentication factors

- **Four** classes of authentication factors
- Something the user **knows**
 - Password, PIN, answer to “secret question”
- Something the user **has**
 - ATM card, badge, browser cookie, physical key, uniform, smartphone
- Something the user **is**
 - Biometrics (fingerprint, voice pattern, face, . . .)
 - Have been used by humans forever, but only recently by computers
- Something about the user's **context**
 - Location, time, devices in proximity

Combination of auth. factors

- **Different classes** of authentication factors can be combined for more solid authentication
 - Two- or multi-factor authentication
- Using multiple factors from the **same** class might not provide better authentication
- “Something you have” can become “something you know”
 - Token can be easily duplicated, e.g., magnetic strip on ATM card
 - SMS message

Passwords

- Probably oldest authentication mechanism used in computer systems
- User enters user ID and password, maybe multiple attempts in case of error
- Usability problems?

Passwords

- Probably oldest authentication mechanism used in computer systems
- User enters user ID and password, maybe multiple attempts in case of error
- Many usability problems, such as
 - Entering passwords is inconvenient, in particular on small screens
 - Password composition/change rules
 - Forgotten passwords might not be recoverable
 - If password is shared among many people, password updates become difficult

Security problems with passwords

- If password is disclosed to unauthorized individual, the individual can immediately access protected resource
 - Unless we use multi-factor authentication
- How can an adversary try to learn your password?

Security problems with passwords

- If password is disclosed to unauthorized individual, the individual can immediately access protected resource
 - Unless we use multi-factor authentication
- Shoulder surfing
- Keystroke logging
- Interface illusions / Phishing
- Password re-use across sites
- Password guessing

Password guessing attacks

- **Brute-force:** Try all possible passwords using exhaustive search
- Can test 350 billion Windows NTLM passwords per second on a cluster of 25 AMD Radeon graphics cards
- Can try 95^8 combinations in 5.5 hours
- Enough to brute force every possible eight-character password containing upper- and lower-case letters, digits, and symbols

Brute-forcing passwords is exponential

<http://erratasec.blogspot.ca/2012/08/common-misconceptions-of-password.html>

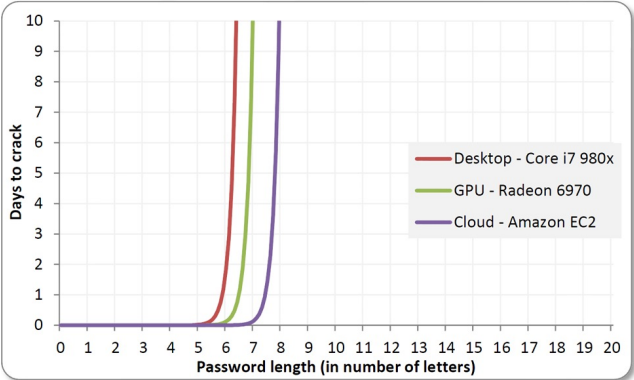

Password guessing attacks

- Exhaustive search assumes that people choose passwords randomly, which is often not the case
- Attacker can do much better by exploiting this
- For example, assume that a password consists of a root and a pre- or postfix appendage
 - “password1”, “abc123”, “123abc”
- Root is from dictionaries (passwords from previous password leaks, names, English words, . . .)
- Appendage is combination of digits, date, single symbol, . . .
- >90% of 6.5 million LinkedIn password hashes leaked in June 2012 were cracked within six days

Password guessing attacks

- So should we just give up on passwords?
- Attack requires that attacker has encrypted password file or encrypted document
 - Offline attack

Password guessing attacks

- So should we just give up on passwords?
- Attack requires that attacker has encrypted password file or encrypted document
 - **Offline attack**
- Instead, attacker might want to guess your banking password by trying to log in to your bank's website
 - **Online attack**
- Online guessing attacks are detectable; how?

Password guessing attacks

- So should we just give up on passwords?
- Attack requires that attacker has encrypted password file or encrypted document
 - **Offline attack**
- Instead, attacker might want to guess your banking password by trying to log in to your bank's website
 - **Online attack**
- Online guessing attacks are detectable
 - Bank shuts down online access to your bank account after n failed login attempts (typically $n \leq 5$)
 - But! How can an attacker circumvent this lockout?

Password hygiene

- Use a password manager to create and store passwords
 - At least for low- and medium-security passwords
 - All (most) eggs are now in one basket, so keep your computer's software up to date
 - Prevents password re-use across sites
 - Autofill option
- Use a pass phrase
 - Phrase of randomly chosen words, avoid common phrases (e.g., advertisement slogans)

Password hygiene

- Use a password manager to create and store passwords
 - At least for low- and medium-security passwords
 - Prevents password re-use across sites
 - Autofill option
 - Problem?
- Use a pass phrase
 - Phrase of randomly chosen words, avoid common phrases (e.g., advertisement slogans)

Password strength

<https://xkcd.com/936/>

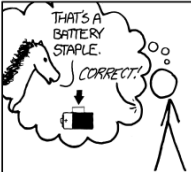
<p>□□□□□□□□□□□□ □</p> <p>UNCOMMON (NON-GIBBERISH) BASE WORD</p> <p>ORDER UNKNOWN</p> <p>Tr0ub4dor &3</p> <p>CAPS? □</p> <p>COMMON SUBSTITUTIONS □□</p> <p>NUMERAL □□</p> <p>PUNCTUATION □□□</p> <p>(YOU CAN ADD A FEW MORE BITS TO ACCOUNT FOR THE FACT THAT THIS IS ONLY ONE OF A FEW COMMON FORMATS.)</p>	<p>~28 BITS OF ENTROPY</p> <p>□□□□□□□□ □</p> <p>□□□□□□□□ □</p> <p>□□ □□</p> <p>□□□□ □</p> <p>$2^{28} = 3 \text{ DAYS AT}$ 1000 GUESSES/SEC</p> <p>(PLAUSIBLE ATTACK ON A WEAK REMOTE WEB SERVICE YES, CRACKING A STOKEN HASH IS FASTER, BUT IT'S NOT WHAT THE AVERAGE USER SHOULD WORRY ABOUT.)</p> <p>DIFFICULTY TO GUESS: EASY</p>	<p>WAS IT TROMBONE? NO, TROUBADOR. AND ONE OF THE 0s WAS A ZERO?</p> <p>AND THERE WAS SOME SYMBOL...</p>  <p>DIFFICULTY TO REMEMBER: HARD</p>
<p>correct horse battery staple</p> <p>□□□□ □□□□ □□□□ □□□□</p> <p>□□□□ □□□□ □□□□ □□□□</p> <p>FOUR RANDOM COMMON WORDS</p>	<p>~44 BITS OF ENTROPY</p> <p>□□□□□□□□□□</p> <p>□□□□□□□□□□</p> <p>□□□□□□□□□□</p> <p>□□□□□□□□□□</p> <p>$2^{44} = 530 \text{ YEARS AT}$ 1000 GUESSES/SEC</p> <p>DIFFICULTY TO GUESS: HARD</p>	<p>THAT'S A BATTERY STAPLE.</p>  <p>CORRECT.</p> <p>DIFFICULTY TO REMEMBER: YOU'VE ALREADY MEMORIZED IT</p>

THROUGH 20 YEARS OF EFFORT, WE'VE SUCCESSFULLY TRAINED EVERYONE TO USE PASSWORDS THAT ARE HARD FOR HUMANS TO REMEMBER, BUT EASY FOR COMPUTERS TO GUESS.

Password hygiene

- Have site-specific passwords
- **Don't reveal passwords** to others
 - In email or over phone
 - If your bank really wants your password over the phone, switch banks
 - Studies have shown that people disclose passwords for a cup of coffee, chocolate, or nothing at all
 - Caveat of these studies?
- Don't enter password that gives access to sensitive information on a **public computer** (e.g., Internet café) or over public networks.
 - Don't do online banking (or anything sensitive) on them

Advice for developers (NIST 2017)

- No password composition rules
 - Otherwise everybody uses the same simple tricks to follow rule
- At least 8 characters minimum length
- At least 64 characters maximum length
- Allow any characters, including space, Unicode, and emoji
- Black list frequently used or compromised passwords (from password leaks)
- Avoid password hints or “secret questions”

Advice for developers (NIST 2017)

- Don't ask users to periodically change passwords
 - Leads to password cycling and similar
 - “myFavoritePwd” -> “dummy” -> “myFavoritePwd”
 - goodPwd.”1” -> goodPwd.”2” -> goodPwd.”3”
- Allow passwords to be copy-pasted into password fields
- Use two-factor authentication (but avoid SMS-based second factor)

Attacks on password files

- Website/computer needs to store information about a password in order to validate entered password
- Storing passwords in plaintext is dangerous, even when file is read protected from regular users
 - Password file might end up on backup tapes
 - Intruder into OS might get access to password file
 - System administrator has access to file and might use passwords to impersonate users at other sites
 - Many people re-use passwords across multiple sites

Cryptographic Tools

The following cryptographic tools are useful for storing information about passwords (see Module 5 for details):

- Cryptographic hash: Compute a fixed-length, deterministic output value from a variable-length input value. Given an output value, it is hard to find an input value with this output value, i.e., a cryptographic hash is not reversible.

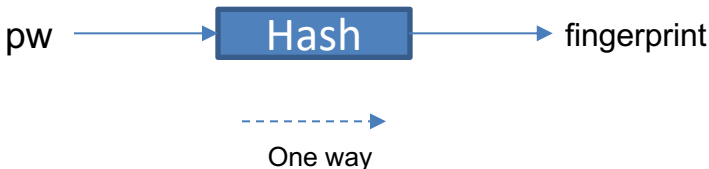

Cryptographic Tools

The following cryptographic tools are useful for storing information about passwords (see Module 5 for details):

- MAC: Same as a cryptographic hash, but it takes a secret key as another input value. Still deterministic and not reversible. Changing the secret key will change the output value.

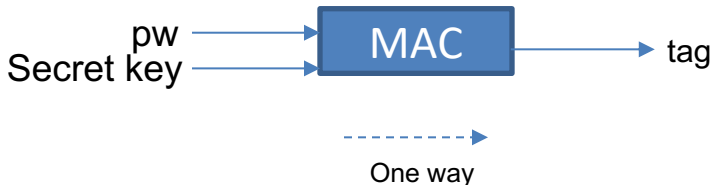

Cryptographic Tools

- (Symmetric) encryption: Compute a non-deterministic output value that is an encryption of the input value under a secret key. Encryption is reversible if we know the secret key (“decryption”).

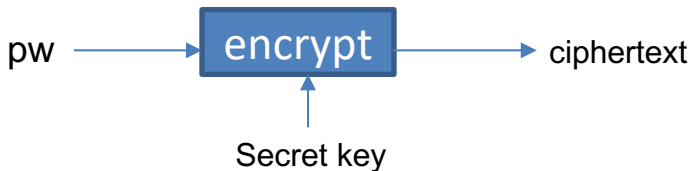

Storing password fingerprints

- Store only a **digital fingerprint** of the password (using a cryptographic hash) in the password file
- When logging in, system computes fingerprint of entered password and compares it with user's stored fingerprint
- Still allows offline guessing attacks when password file leaks

Defending against guessing attacks

- UNIX makes guessing attacks harder by including **user-specific salt** in the password fingerprint
 - Salt is initially derived from time of day and process ID of /bin/passwd
 - Salt is then stored in the password file in plaintext

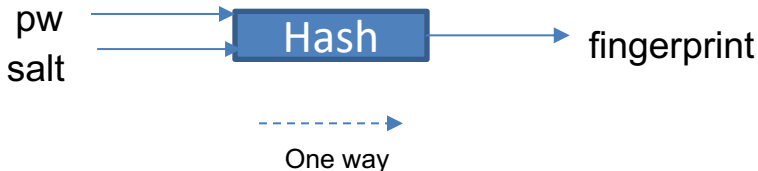

Defending against guessing attacks

- UNIX makes guessing attacks harder by including **user-specific salt** in the password fingerprint
 - Salt is initially derived from time of day and process ID of /bin/passwd
 - Salt is then stored in the password file in plaintext
- Two users who happen to have the same password will likely have different fingerprints
- Makes guessing attacks harder, can't just build a single table of fingerprints and passwords and use it for any password file

Defending against guessing attacks

- Don't use a standard cryptographic hash (like SHA-1 or SHA-512) to compute the stored fingerprint
- They are relatively cheap to compute (microseconds)
- Instead use an iterated hash function that is expensive to compute (e.g., bcrypt) and maybe also uses lots of memory (e.g., scrypt)
 - Hundreds of milliseconds
- This slows down a guessing attack significantly, but is barely noticed when a users enters his/her password

Defending against guessing attacks

- An additional defense is to use a MAC, instead of a cryptographic hash
- A MAC mixes in a secret key to compute the password fingerprint
- If the fingerprints leak, guessing attacks aren't useful anymore
- Can protect the secret key by embedding it in tamper resistant hardware (Expensive?)
- If the key does leak, the scheme remains as secure as a scheme based on a cryptographic hash

Password Recovery

- A password cannot normally be recovered from a hash value (fingerprint)
- If password recovery is desired, it is necessary to store an **encrypted version** of the password in the password file
- We need to keep encryption key away from attacker

Password Recovery

- As opposed to fingerprints, this approach allows the system to (easily) re-compute a password if necessary
 - E.g., have system email password **in the clear** to predefined email address when user forgets password
- There are many problems with this approach!
- Password reset is more common now.

The Adobe Password Hack (November 2013)

- In November 2013, 130 million **encrypted** passwords for Adobe accounts were revealed.
- The encryption mechanism was the following:
 - ① First a NUL byte was appended to the password.
 - ② Next, additional NUL bytes were appended as required to make the length a multiple of 8 bytes.
 - ③ Then the padded passwords were encrypted 8 characters at a time using a fixed key. (This is called **ECB mode** and it is the **weakest possible** encryption mode.)
- The password hints were not encrypted.
- It turns out that many passwords can be decrypted, without breaking the encryption and not knowing the key.

The Adobe Password Hack (cont.)

Adobe password data	Password hint
110edf2294fb8bf4	-> numbers 123456
110edf2294fb8bf4	-> ==123456
110edf2294fb8bf4	-> c'est "123456"
8fda7e1f0b56593f e2a311ba09ab4707	-> numbers
8fda7e1f0b56593f e2a311ba09ab4707	-> 1-8
8fda7e1f0b56593f e2a311ba09ab4707	-> 8digit
2fca9b003de39778 e2a311ba09ab4707	-> the password is password
2fca9b003de39778 e2a311ba09ab4707	-> password
2fca9b003de39778 e2a311ba09ab4707	-> rhymes with assword
e5d8efed9088db0b	-> q w e r t y
e5d8efed9088db0b	-> ytrewq tagurpidi
e5d8efed9088db0b	-> 6 long qwert
ecba98cca55eabc2	-> sixxone
ecba98cca55eabc2	-> 1*6
ecba98cca55eabc2	-> sixones

HACKERS RECENTLY LEAKED 153 MILLION ADOBE USER EMAILS, ENCRYPTED PASSWORDS, AND PASSWORD HINTS.

ADOBE ENCRYPTED THE PASSWORDS IMPROPERLY, MISUSING BLOCK-MODE 3DES. THE RESULT IS SOMETHING WONDERFUL:

USER	PASSWORD	HINT	
4e18acc1ab27a2d6		WEATHER VANE SWORD	<input type="text"/>
4e18acc1ab27a2d6			<input type="text"/>
4e18acc1ab27a2d6	a0a2876c61ea1fca	NAME 1	<input type="text"/>
8bab6279e06eb6d		DUH	
8bab6279e06eb6d	a0a2876c61ea1fca		<input type="text"/>
8bab6279e06eb6d	85e94a81a3a78adc	57	
4e18acc1ab27a2d6		FAVORITE OF 12 APOSTLES	
1ab29ae86d46e5ca	7a24a0a2876eb1e	WITH YOUR OWN HAND YOU HAVE DONE ALL THIS	
a1f9b2b6299e7b2b	ea0ec1e6a6797397	SEXY EARLOBES	<input type="text"/>
a1f9b2b6299e7b2b	617ab0277727ad85	BEST TOS EPISODE	<input type="text"/>
39738b7adb068a17	617ab0277727ad85	SUGARLAND	
1ab29ae86d46e5ca		NAME + JERSEY #	
877ab7889d3862b1		ALPHA	<input type="text"/>
877ab7889d3862b1			<input type="text"/>
877ab7889d3862b1			<input type="text"/>
877ab7889d3862b1		OBVIOUS	<input type="text"/>
877ab7889d3862b1		MICHAEL JACKSON	<input type="text"/>
38a7c9279c0deb44	9dca1d79d4dec6d5		
38a7c9279c0deb44	9dca1d79d4dec6d5	HE DID THE MASH, HE DID THE	
38a7c9279c0deb44		PURLINED	<input type="text"/>
a8ae57d5c7a7af7a	9dca1d79d4dec6d5	FAV. LATER-3 POKEMON	<input type="text"/>

THE GREATEST CROSSWORD PUZZLE
IN THE HISTORY OF THE WORLD

<http://xkcd.com/1286>

Interception attacks

- Attacker intercepts password while it is in transmission from client to server
- One-time passwords make intercepted password useless for **later** logins
 - Fobs (e.g., RSA SecurID), Authenticator apps
 - Challenge-response protocols

Interception attacks

- On the web, passwords may still be transmitted in plaintext
 - Sometimes, digital fingerprint of them
 - Encryption (TLS, see later) protects against interception attacks **on the network**
- There are cryptographic protocols (e.g., SRP) that make intercepted information useless to an attacker
- Alternative solutions are difficult to deploy
 - Patent issues, changes to HTTP protocol, hardware
- And don't help against interception on the client side
 - Malware

Android unlock patterns

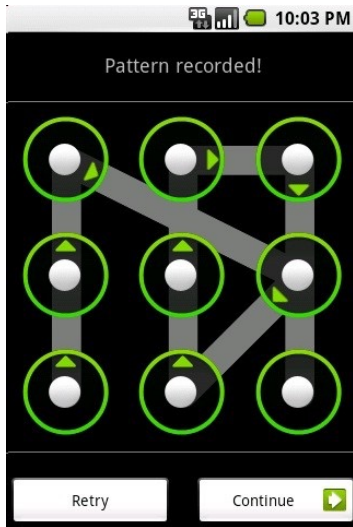

Graphical passwords

- Graphical passwords are an alternative to text-based passwords
- Multiple techniques, e.g.,
 - User chooses a picture; to log in, user has to re-identify this picture in a set of pictures
 - User chooses set of places in a picture; to log in, user has to click on each place
- Issues?

Graphical passwords

- Graphical passwords are an alternative to text-based passwords
- Multiple techniques, e.g.,
 - User chooses a picture; to log in, user has to re-identify this picture in a set of pictures
 - User chooses set of places in a picture; to log in, user has to click on each place
- Issues similar to text-based passwords arise
 - E.g., choice of places is not necessarily random
- Shoulder surfing becomes a problem
- Ongoing research

Server authentication

- With the help of a password, system authenticates user (client)
- But **user should also authenticate system (server)** else password might end up with attacker!
- Classic attack:
 - Program displays fake login screen
 - When user “logs in”, program prints error message, sends captured user ID/password to attacker, and ends current session (which results in real login screen)
 - That’s why Windows trains you to press <CTRL-ALT-DELETE> for login, key combination cannot be overridden by attacker
- Today’s attack:
 - **Phishing**

Biometrics

- Biometrics have been hailed as a way to get rid of the problems with password and token-based authentication
- Unfortunately, they have their own problems
- Idea: Authenticate user based on **physical characteristics**
 - Fingerprints, iris scan, voice, handwriting, typing pattern, . . .
- If observed trait is **sufficiently close** to previously stored trait, accept user
 - Observed fingerprint will never be completely identical to a previously stored fingerprint of the same user

Local vs. remote authentication

- Biometrics work well for local authentication, but are less suited for remote authentication or for identification
- In local authentication, a guard can ensure that:
 - I put my own finger on a fingerprint scanner, not one made out of gelatin
 - I stand in front of a camera and don't just hold up a picture of somebody else
- In remote authentication, this is much more difficult

Authentication vs. identification

- Authentication: Does a captured trait correspond to a particular stored trait?
- Identification: Does a captured trait correspond to any of the stored traits?
 - Identification is an (expensive) **search problem**, which is made worse by the fact that in biometrics, matches are based on closeness, not on equality (as for passwords)
- **False positives** can make biometrics-based identification useless
 - False positive: Alice is accepted as Bob
 - False negative: Alice is incorrectly rejected as Alice

Biometrics-based identification

- Example (from Bruce Schneier's "Beyond Fear"):
 - Face-recognition software with (unrealistic) accuracy of 99.9% is used in a football stadium to detect terrorists
 - 1-in-1,000 chance that a terrorist is not detected
 - 1-in-1,000 chance that innocent person is flagged as terrorist
 - If one in 10 million stadium attendees is a **known** terrorist, there will be 10,000 false alarms for every real terrorist
 - Remember "The Boy Who Cried Wolf"?

Other problems with biometrics

- **Privacy**
 - Why should my employer (or a website) have information about my fingerprints, iris,..?
 - Aside: Why should a website know my date of birth, my mother's maiden name,.. for "secret questions"?
 - What if this information leaks? Getting a new password is easy, but much more difficult for biometrics
- **Accuracy**: False negatives are annoying
 - What if there is no other way to authenticate?
 - What if I grow a beard, hurt my finger,.. ?

Other problems with biometrics

- **Secrecy**: Some of your biometrics are not particularly secret
 - Face, fingerprints,...
- **Legal protection**: The law may allow the police to put your finger on your phone's fingerprint reader (or simply hold your phone's camera in front of you). But the law may protect you from you having to reveal your password (depending on the country).

Module outline

- 1 Protection in general-purpose operating systems
- 2 Access control
- 3 User authentication
- 4 Security policies and models
- 5 Trusted operating system design

Trusted operating systems

- Trusting an entity means that if this entity misbehaves, the security of the system fails
- We trust an OS if we have **confidence** that it provides security services, i.e.,
 - Memory and file protection
 - Access control and user authentication

Trusted operating systems

Typically a trusted operating system builds on four factors:

- **Policy**: A set of rules outlining what is secured and why
- **Model**: A model that implements the policy and that can be used for reasoning about the policy
- **Design**: A specification of how the OS implements the model
- **Trust**: Assurance that the OS is implemented according to design

Trusted software

- Software that has been rigorously developed and analyzed, giving us reason to trust that the code does what it is expected to do **and nothing more**
- **Functional correctness**
 - Software works correctly
- **Enforcement of integrity**
 - Wrong inputs don't impact correctness of data
- **Limited privilege**
 - Access rights are minimized and not passed to others
- **Appropriate confidence level**
 - Software has been rated as required by environment
- Trust can change over time, e.g., based on experience

Security policies

- Many OS security policies have their roots in military security policies
- Each object/subject has a sensitivity/clearance level
 - “Top Secret” $>_C$ “Secret” $>_C$ “Confidential” $>_C$ “Unclassified”
where “ $>_C$ ” means “more sensitive”
- Each object/subject might also be assigned to one or more compartments
 - E.g., “Soviet Union”, “East Germany”
 - **Need-to-know rule**
- Subject s can access object o iff $\text{level}(s) \geq \text{level}(o)$ and $\text{compartments}(s) \supseteq \text{compartments}(o)$
 - **s dominates o** , short “ $s \geq_{dom} o$ ”

Example

- Secret agent James Bond has clearance “Top Secret” and is assigned to compartment “East Germany”
- Can he read a document with sensitivity level “Secret” and compartments “East Germany” and “Soviet Union”?
- Which documents can he read?

Commercial security policies

- Rooted in military security policies
- Different classification levels for information
 - E.g., external vs. internal
- Different departments/projects can call for need-to-know restrictions
- Assignment of people to clearance levels typically not as formally defined as in military
 - Maybe on a temporary/ad hoc basis

Other security policies

- So far we've looked only at confidentiality policies
- Integrity of information can be as or even more important than its confidentiality
 - E.g., Clark-Wilson Security Policy
 - Based on **well-formed transactions** that transition system from a consistent state to another one
 - Also supports Separation of Duty (see RBAC slides)
- Another issue is dealing with **conflicts of interests**
 - Chinese Wall Security Policy
 - Once you've decided for a side of the wall, there is no easy way to get to the other side

Chinese Wall security policy

- Once you have been able to access information about a particular kind of company, you will no longer be able to access information about other companies of the same kind
 - Useful for consulting, legal or accounting firms
 - Need history of accessed objects
 - Access rights change over time
- **ss-property**: Subject s can access object o iff each object previously accessed by s either belongs to the same company as o or belongs to a different kind of company than o does
- ***-property**: For a write access to o by s , we also need to ensure that all objects readable by s either belong to the same company as o or have been sanitized

Example

- Fast Food Companies = {McDonalds, Wendy's}
- Book Stores = {Chapters, Amazon}
- Alice has accessed information about McDonalds
- Bob has accessed information about Wendy's
- ss-property prevents Alice from accessing information about Wendy's, but not about Chapters or Amazon
 - Similar for Bob
- Suppose Alice could write information about McDonalds to Chapters and Bob could read this information from Chapters
 - Indirect information flow violates Chinese Wall Policy
 - *-property forbids this kind of write

Security models

- Many security models have been defined and interesting properties about them have been proved
- Unfortunately, for many models, their relevance to practically used security policies is not clear
- We'll focus on two prominent models
 - Bell-La Padula Confidentiality Model
 - Biba Integrity Model
- Targeted at Multilevel Security (MLS) policies, where subjects/objects have clearance/classification levels

Lattices

- Dominance relationship \geq_{dom} defined in military security model is transitive and antisymmetric
- Therefore, it defines a **partial** order (neither $a \geq_{dom} b$ nor $b \geq_{dom} a$ might hold for two levels a and b)
- In a **lattice**, for every a and b , there is a **unique lowest upper bound** u for which $u \geq_{dom} a$ and $u \geq_{dom} b$ and a **unique greatest lower bound** l for which $a \geq_{dom} l$ and $b \geq_{dom} l$
- There are also two elements U and L that dominate/are dominated by all levels
 - $U = (\text{"Top Secret"}, \{\text{"Soviet Union"}, \text{"East Germany"}\})$
 - $L = (\text{"Unclassified"}, \emptyset)$

Example lattice

Sensitivity levels:
TS = Top Secret
S = Secret
U = Unclassified

Compartments:
SU = Soviet Union
EG = East Germany

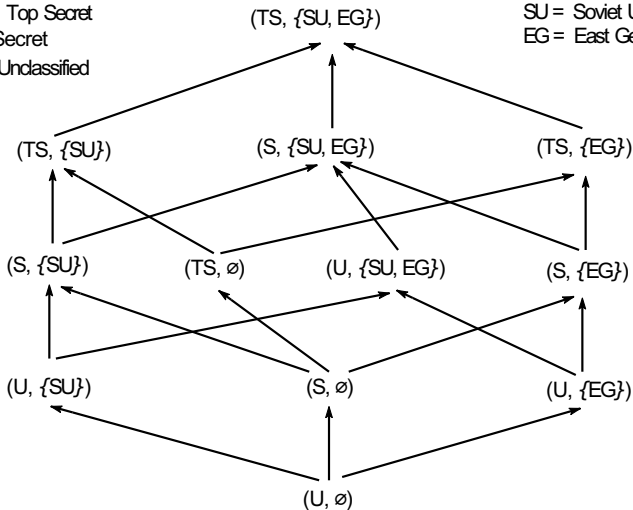

Bell-La Padula confidentiality model

- Regulates **information flow** in MLS policies, e.g., lattice-based ones
- Users should get information only according to their clearance
- Should subject s with clearance $C(s)$ have access to object o with sensitivity $C(o)$?
- Underlying principle: Information can only flow **up**
- ss-property (“**no read up**”): s should have read access to o only if $C(s) \geq_{dom} C(o)$
- *-property (“**no write down**”): s should have write access to o only if $C(o) \geq_{dom} C(s)$

Example

- No read up is straightforward
- No write down avoids the following leak:
 - James Bond reads secret document and summarizes it in a confidential document
 - Miss Money Penny with clearance “confidential” now gets access to secret information
- In practice, subjects are programs (acting on behalf of users)
 - Else James Bond couldn't even talk to Miss Money Penny
 - If program accesses secret information, OS ensures that it can't write to confidential file later
 - Even if program does not leak information
 - Might need explicit declassification operation for usability purposes

Biba integrity model

- Prevent inappropriate **modification** of data
- Dual of Bell-La Padula model
- Subjects and objects are ordered by an integrity classification scheme, $I(s)$ and $I(o)$
- Should subject s have access to object o ?
- Write access: s can modify o only if $I(s) \geq_{dom} I(o)$
 - Unreliable person cannot modify file containing high integrity information
- Read access: s can read o only if $I(o) \geq_{dom} I(s)$
 - Unreliable information cannot “contaminate” subject

Low Watermark Property

- Biba's access rules are very restrictive, a subject cannot ever read lower integrity object
- Can use dynamic integrity levels instead
 - **Subject Low Watermark Property:**
If subject s reads object o , then $I(s) = \text{glb}(I(s), I(o))$,
where $\text{glb}()$ = greatest lower bound
 - **Object Low Watermark Property:**
If subject s modifies object o , then $I(o) = \text{glb}(I(s), I(o))$
- Integrity of subject/object can only go down, information flows **down**

Review of Bell-La Padula & Biba

- Very simple, which makes it possible to prove properties about them
 - E.g., can prove that if a system starts in a secure state, the system will remain in a secure state
- Probably too simple for great practical benefit
 - Need declassification
 - Need both confidentiality and integrity, not just one
 - What about object creation?
- Information leaks might still be possible through covert channels in an implementation of the model

Information flow control

- An information flow policy describes authorized paths along which information can flow
- For example, Bell-La Padula describes a lattice-based information flow policy
- In compiler-based information flow control, a compiler checks whether the information flow in a program could violate an information flow policy
- How does information flow from a variable x to a variable y ?
- Explicit flow: E.g., $y := x$; or $y := x / z$;
- Implicit flow: $\text{If } x = 1 \text{ then } y := 0$;
 $\text{else } y := 1$

Information flow control (cont.)

- Input parameters of a program have a (lattice-based) security classification associated with them
- Compiler then goes through the program and updates the security classification of each variable depending on the individual statements that update the variable (using dynamic BLP/Biba)
- Ultimately, a security classification for each variable that is output by the program is computed
- User (more likely, another program) is allowed to see this output only if allowed by the user's (program's) security classification

Module outline

- 1 Protection in general-purpose operating systems
- 2 Access control
- 3 User authentication
- 4 Security policies and models
- 5 Trusted operating system design

Trusted system design elements

- Design must address which objects are accessed how and which subjects have access to what
 - As defined in security policy and model
- Security must be **part of design early on**
 - Hard to retrofit security, see Windows 95/98

Android Security Evolution

- Single User

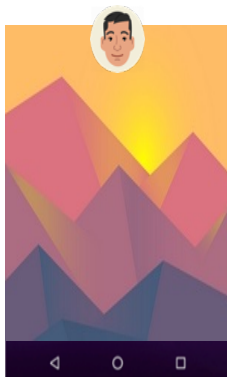

- Multi User

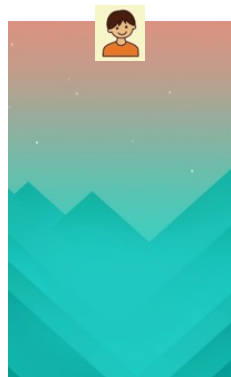
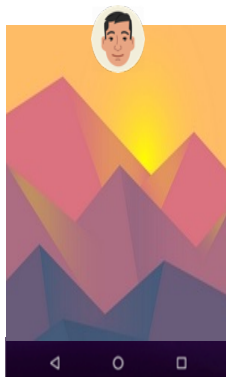

- New Security requirement “to be added”

Android Security Evolution

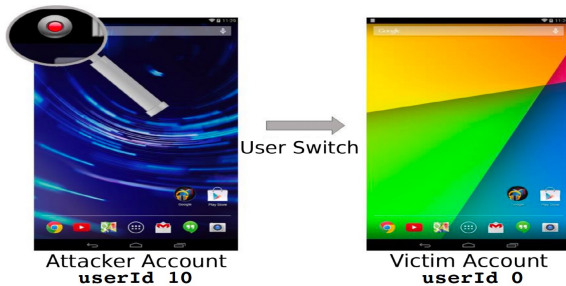

Trusted system design elements

- Design must address which objects are accessed how and which subjects have access to what
 - As defined in security policy and model
- Security must be **part of design early on**
 - Hard to retrofit security, see Windows 95/98
- Eight design principles for security
- **Least privilege**
 - Operate using fewest privileges possible
- **Economy of mechanism**
 - Protection mechanism should be simple and straightforward
- **Open design**
 - Avoid **security by obscurity**
 - Secret keys or passwords, but not secret algorithms

Security design principles (cont.)

- **Complete mediation**
 - Every access attempt must be checked
- **Permission based / Fail-safe defaults**
 - Default should be denial of access
- **Separation of privileges**
 - Two or more conditions must be met to get access
- **Least common mechanism**
 - Every shared mechanism could potentially be used as a covert channel
- **Ease of use**
 - If protection mechanism is difficult to use, nobody will use it or it will be used in the wrong way

Weakest link: Incomplete mediation



Security design principles (cont.)

- **Complete mediation**
 - Every access attempt must be checked
- **Permission based / Fail-safe defaults**
 - Default should be denial of access
- **Separation of privileges**
 - Two or more conditions must be met to get access
- **Least common mechanism**
 - Every shared mechanism could potentially be used as a covert channel
- **Ease of use**
 - If protection mechanism is difficult to use, nobody will use it or it will be used in the wrong way

Default Allow Vs Default Deny

- **Default Allow / Blacklist**
- Allow everything, unless malice is spotted

- **Default Deny / whitelist**
- Deny everything, allow if safe

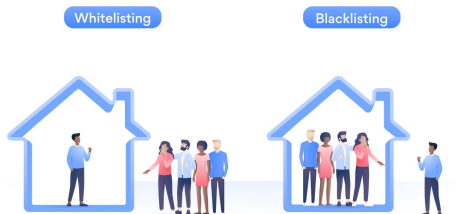

Security design principles (cont.)

- **Complete mediation**
 - Every access attempt must be checked
- **Permission based / Fail-safe defaults**
 - Default should be denial of access
- **Separation of privileges**
 - Two or more conditions must be met to get access
- **Least common mechanism**
 - Every shared mechanism could potentially be used as a covert channel
- **Ease of use**
 - If protection mechanism is difficult to use, nobody will use it or it will be used in the wrong way

Principle of ease of use

- (Prior) Android permission granting model

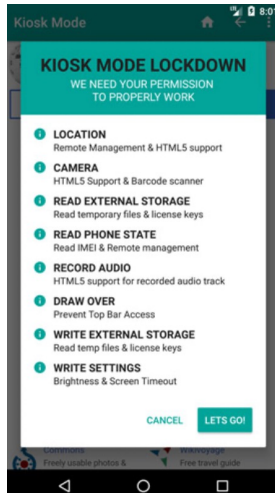

Principle of ease of use

- (New) Android permission granting model

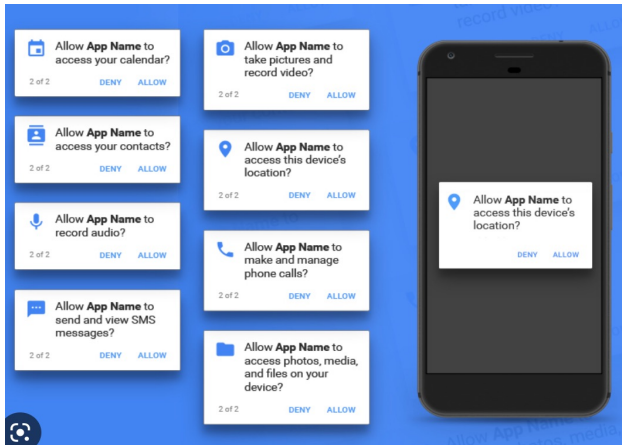

Security features of trusted OS

- Identification and authentication
 - See earlier
- Access control
- Object reuse protection
- Trusted path
- Accountability and audit
- Intrusion detection

Access control

- **Mandatory access control (MAC)**
 - Central authority establishes who can access what
 - Good for military environments
 - For implementing Chinese Wall, Bell-La Padula, Biba
- **Discretionary access control (DAC)**
 - Owners of an object have (some) control over who can access it
 - You can grant others access to your home directory
 - e.g., UNIX and Windows
- **RBAC** is neither MAC nor DAC
- Possible to use combination of these mechanisms

Object reuse protection

- Alice allocates memory from OS and stores her password in this memory
- After using password, she returns memory to OS
 - By calling `free()` or simply by exiting procedure if memory is allocated on stack
- Later, Bob happens to be allocated the same piece of memory and he finds Alice's password in it
- OS should erase returned memory before handing it out to other users
- **How can we defend against this?**

Object reuse protection

- Alice allocates memory from OS and stores her password in this memory
- After using password, she returns memory to OS
 - By calling `free()` or simply by exiting procedure if memory is allocated on stack
- Later, Bob happens to be allocated the same piece of memory and he finds Alice's password in it
- OS should erase returned memory before handing it out to other users
- Defensive programming: Erase sensitive data yourself before returning it to OS
 - How can compiler interfere with your good intentions?
- Similar problem exists for files, registers and storage media

Object reuse protection

- Uninstalling apps

Sms messages DB



SMS APP: "com.defaultsms"

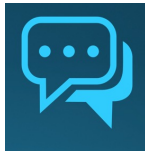

Object reuse protection

- Uninstalling apps

Sms messages DB



Uninstall: SMS APP: “com.defaultsms”

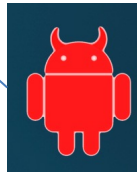
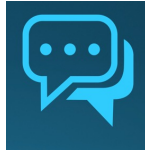

Uninstall: Malicious APP: “com.defaultsms”

Hidden data

- Hidden data is related to object reuse protection
- You think that you deleted some data, but it is still hidden somewhere

Examples?

Hidden data

- Hidden data is related to object reuse protection
- You think that you deleted some data, but it is still hidden somewhere
 - Deleting a file will not physically erase file on disk
 - Deleting an email in GMail will not remove email from Google's backups
 - Deleting text in MS Word might not remove text from document
 - Putting a black box over text in a PDF leaves text in PDF
 - Shadow Copy feature of Windows 7 keeps file snapshots to enable restores

Trusted path

- Give assurance to user that her keystrokes and mouse clicks are sent to legitimate receiver application
- Remember the fake login screen?
- Turns out to be quite difficult for existing desktop environments, both Linux and Windows
 - Don't run sudo if you have an untrusted application running on your desktop

Accountability and audit

- Keep an audit log of all security-related events
- Provides accountability if something goes bad
 - Who deleted the sensitive records in the database?
 - How did the intruder get into the system?
- An audit log does not give accountability if attacker can modify the log
- At what **granularity** should events be logged?
 - For fine-grained logs, we might run into space/efficiency problems or finding actual attack can be difficult
 - For coarse-grained logs, we might miss attack entirely or don't have enough details about it

Intrusion detection

- There shouldn't be any intrusions in a trusted OS
- However, writing bug-free software is hard, people make configuration errors,...
- Audit logs might give us some information about an intrusion
- Ideally, OS detects an intrusion as it occurs
- Typically, by correlating actual behaviour with normal behaviour
- Alarm if behaviour looks abnormal
- See later in Network Security module

Trusted computing base (TCB)

- TCB consists of the part of a trusted OS that is necessary to enforce OS security policy
 - Changing non-TCB part of OS won't affect OS security, changing its TCB-part will
 - TCB better be complete and correct
- TCB can be implemented either in different parts of the OS or in a separate security kernel
- Separate security kernel makes it easier to validate and maintain security functionality
- Security kernel runs below the OS kernel, which makes it more difficult for an attacker to subvert it

Security kernel

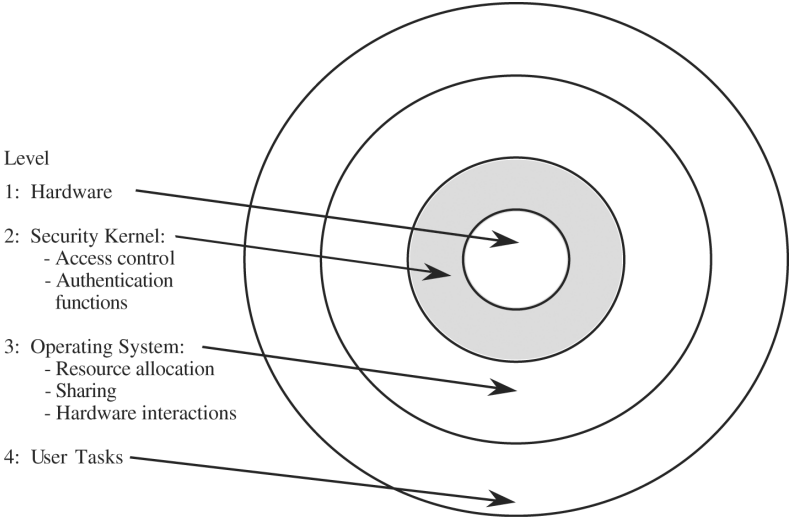

Rings

- Some processors support this kind of layering based on “rings”
- If processor is operating in ring n , code can access only memory and instructions in rings $\geq n$
- Accesses to rings $< n$ trigger interrupt/exception and inner ring will grant or deny access
- x86 architecture supports four rings, but Linux and Windows use only two of them
 - user and supervisor mode
 - i.e., don't have security kernel
- Some research OSs (Multics, SCOMP) use more

Reference monitor

- Crucial part of the TCB
- Collection of access controls for devices, files, memory, IPC, . . .
- Not necessarily a single piece of code
- Must be **tamperproof, unbyassable, and analyzable**
- Interacts with other security mechanism, e.g., user authentication

Virtualization

- Virtualization is a way to provide logical separation (isolation)
- Different degrees of virtualization
- **Virtual memory**
 - Page mapping gives each process the impression of having a separate memory space
- **Virtual machines**
 - Also virtualize I/O devices, files, printers, . . .
 - Examples?
 - Security usage scenarios?

Virtualization

- Virtualization is a way to provide logical separation (isolation)
- Different degrees of virtualization
- **Virtual memory**
 - Page mapping gives each process the impression of having a separate memory space
- **Virtual machines**
 - Also virtualize I/O devices, files, printers, . . .
 - Currently very popular (VMware, Xen, Parallels, . . .)
 - If Web browser runs in a virtual machine, browser-based attacks are limited to the virtual environment
 - On the other hand, a rootkit could make your OS run in a virtual environment and be very difficult to detect (“Blue Pill”)

Application Insulation

- Memory encryption techniques allow application shielding from other apps, OS, some hardware attacks
- Application is partitioned into trusted and untrusted code.
- Trusted computing base is reduced to secure hardware, CPU and (hopefully small) trusted code
- Two examples: Intel SGX and AMD memory encryption

Least privilege in popular OSs

- Pretty poor
- Windows pre-NT: any user process can do anything
- Windows pre-Vista: fine-grained access control.
However, in practice, many users just ran as administrators, which can do anything
 - Some applications even required it

Least privilege in popular OSs (cont.)

- Traditional UNIX: a root process has access to anything, a user process has full access to user's data
- SELinux and AppArmor provide Mandatory Access Control (MAC) for Linux, which allows the implementation of least privilege
 - No more root user
 - Support both confidentiality and integrity
 - Difficult to set up
- Other, less invasive approaches for UNIX
 - Chroot, compartmentalization, SUID (see next slides)
- What about smartphone operating systems?

Chroot

- **Sandbox/jail** a command by changing its root directory
 - `chroot /new/root command`
- Command cannot access files outside of its jail
- Some commands/programs are difficult to run in a jail
- But there are ways to break out of the jail

Containers

- Files (as in chroot) are not the only thing you might want to isolate from one process to another
- Some OSes (e.g., Linux) support **namespaces** for various resources
 - process IDs, user IDs, network configuration, filesystem mounts, ...
- A **container** can run processes in a set of namespaces isolated from other containers on the same physical (“host”) machine
- Example container systems: lxc, docker
- Having a privilege inside a container does not imply having the privilege in other containers, or on the host machine

Compartmentalization

- Split application into parts and apply least privilege to each part

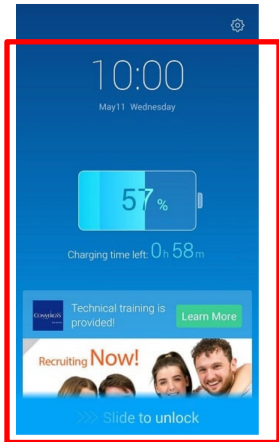

Single LOCK SCREEN APP:

Permission:

- Read Screen TAPS
- Internet

Compartmentalization

- Split application into parts and apply least privilege to each part

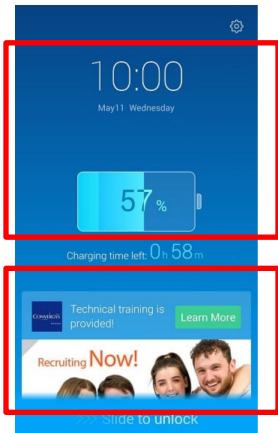

LOCK SCREEN APP – Main comp:

Permission:

- Read Screen TAPS

LOCK SCREEN APP – adv comp:

Permission:

- Internet

setuid/suid bit

- In addition to bits denoting read, write and execute access rights, UNIX ACLs also contain an suid bit
- If suid bit is set for an executable, the executable will execute under the identity of its owner, not under the identity of the caller
 - /usr/bin/passwd belongs to root and has suid bit set
 - If a user calls /usr/bin/passwd, the program will assume the root identity and can thus update the password file

Assurance

- How can we convince **others** to trust our OS?
- **Testing**
 - Can demonstrate existence of problems, but not their absence
 - Might be infeasible to test all possible inputs
 - Penetration testing: Ask outside experts to break into your OS
- **Formal verification**
 - Use mathematical logic to prove correctness of OS
 - Has made lots of progress recently
 - Unfortunately, OSs are probably growing faster in size than research advances

Assurance (cont.)

- **Validation**
 - Traditional software engineering methods
 - Requirements checking, design and code reviews, system testing

Evaluation

- Have trusted entity evaluate OS and certify that OS satisfies some criteria
- Two well-known sets of criteria are the “**Orange Book**” of the U.S. Department of Defence and the **Common Criteria**
- Orange Book lists several ratings, ranging from “D” (failed evaluation, no security) to “A1” (requires formal model of protection system and proof of its correctness, formal analysis of covert channels)
 - See text for others
 - Windows NT has C2 rating, but only when it is not networked and with default security settings changed
 - Most UNIXes are roughly C1

Common criteria

- Replace Orange Book, more international effort
- Have **Protection Profiles**, which list security threats and objectives
- Products are rated against these profiles
- Ratings range from EAL 1 (worst) to EAL 7 (best)
- Windows XP has been rated EAL 4+ for the Controlled Access Protection Profile (CAPP), which is derived from Orange Book's C2
 - Interestingly, the continuous release of security patches for Windows XP did not affect its rating
- Windows 7, Red Hat Enterprise Linux 6 were also rated EAL 4+

Recap

- Protection in general-purpose operating systems
- Access control
- User authentication
- Security policies and models
- Trusted operating system design